

PCA-COM

Power Connection and End Termination Kit

INSTALLATION PROCEDURES

for FLX, HSX

**For Power Connection, In-Line Splice Connection,
T-Splice Connection, or End Termination Applications**

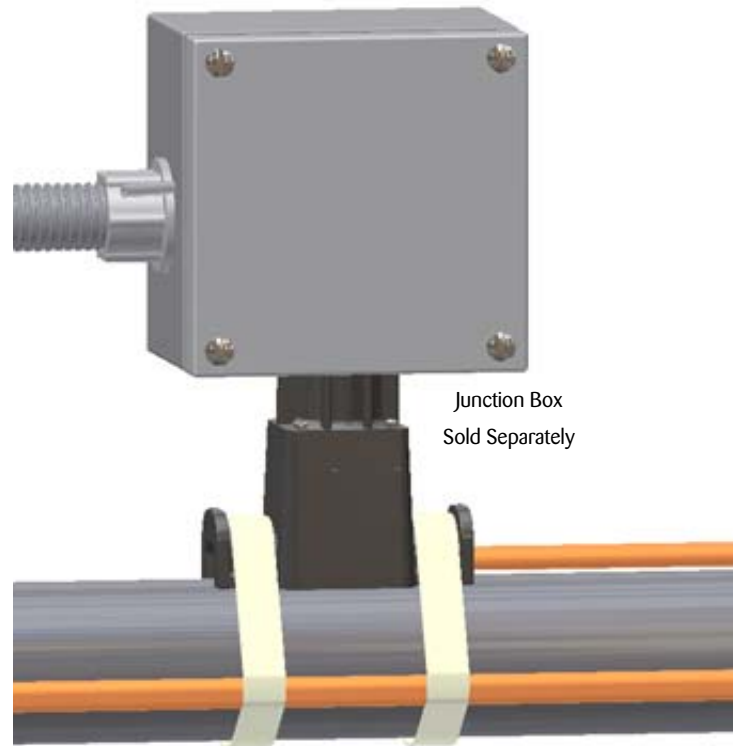

The Heat Tracing Specialists®

PCA-COM Power Connection and End Termination Kit

The following installation procedures are suggested guidelines for the installation of Thermon's PCA-COM connection systems. They are not intended to preclude the use of other methods and good engineering or field construction practices.

Receiving, Storing and Handling . . .

1. Inspect materials for damage incurred during shipping.
2. Report damages to the carrier for settlement.
3. Identify parts against the packing list to ensure the proper type and quantity have been received.
4. Store in a dry location.

Kit Contents . . .

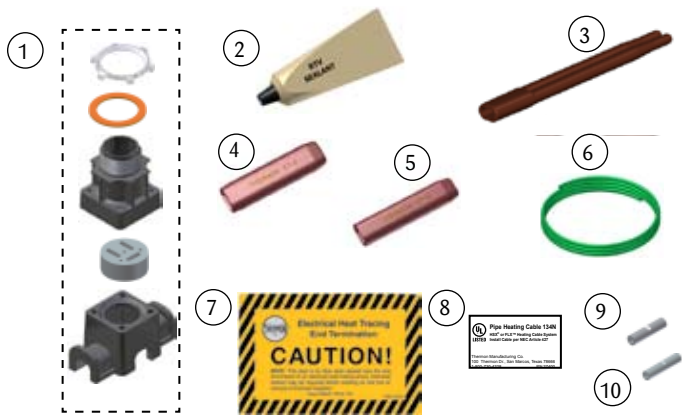

Item	Quantity	Description
1	1	Expediter Assembly Locknut Gasket 1" NPT Threaded Cap Grommet Expediter Base
2	1	RTV Tube
3	1	Power Connection Boot
4	1	End Cap ET-6 (FLX-OJ and HSX Cable)
5	1	End Cap ET-8 (FLX-BC Cable)
6	1	12 AWG Green Ground Lead
7	1	End Termination Caution Label
8	1	UL Label
9	1	8 awg Splice Lug
10	1	12/10 awg Splice Lug

Installation Precautions . . .

- To minimize the potential for arcing and fire caused by product damage or improper installation use ground-fault protection. The National Electrical Code (NEC) and Canadian Electrical Code (CEC) require ground-fault protection of equipment for each branch circuit supplying electric heat tracing.
- Installation must comply with Thermon requirements and be installed in accordance with the NEC, CEC, or any other applicable national and local codes.
- De-energize all power sources before opening enclosure.
- Keep ends of heating cable and kit components dry before and during installation.
- Component approvals and performance ratings are based on the use of Thermon specified parts only. User supplied power connection fittings must be listed or certified for intended use.
- The kit instructions should be used in conjunction with the installation instructions for the heating cable and other accessory items.

Certifications/Approvals . . .



Tools Required . . .

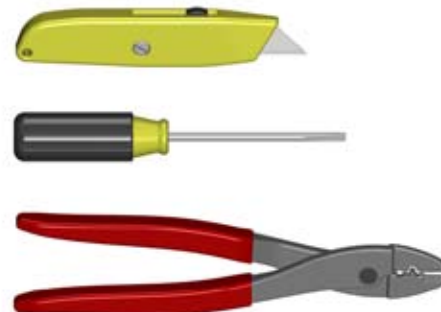

PCA-COM

Power connection for FLX -OJ cables and HSX cables. For cables with braid only, skip to Step 3.1 on page 4.



1.1a. For one, two or three cables. Insert cable into expediter, grommet, and NPT threaded cap.



1.1b. Two cables.



1.1c. Three cables.

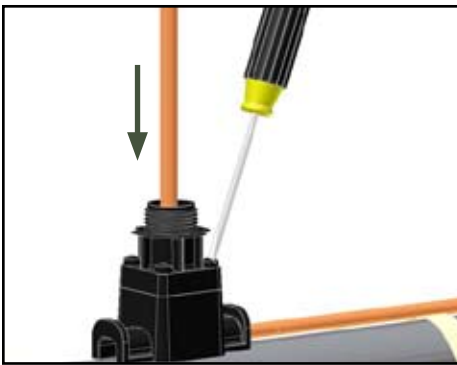

1.2. Slide expediter toward pipe and secure cap to base with the captive screws.

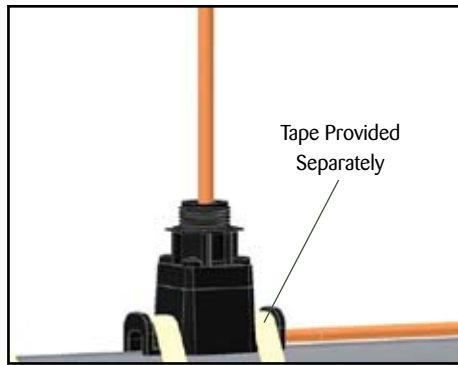

1.3. Mount expediter to pipe using two (2) circumferential bands of 19mm (3/4") wide tape.
Tape Provided Separately

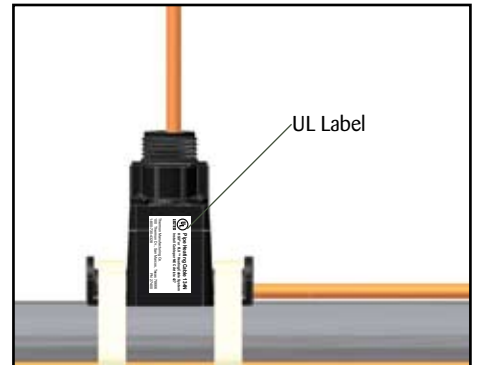

1.4. Place UL[®] label provided as shown, locate on opposite side from rectangular side opening.

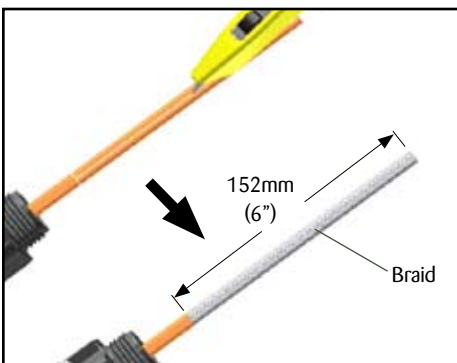

1.5. Cut and remove heating cable overjacket.



Do not cut bus metallic braid.



1.6. Separate braid strands at edge of overjacket and pull cable through opening.



1.7. Twist braid into a pigtail. Trim ends of braid.



The Heat Tracing Specialists[®]

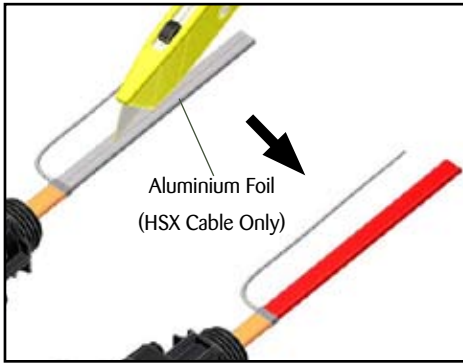

1.8. Gently score the aluminium foil layer and peel away. (HSX cables only).

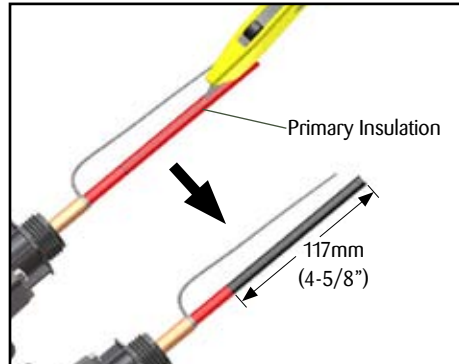

1.9. Cut and remove primary insulation jacket.

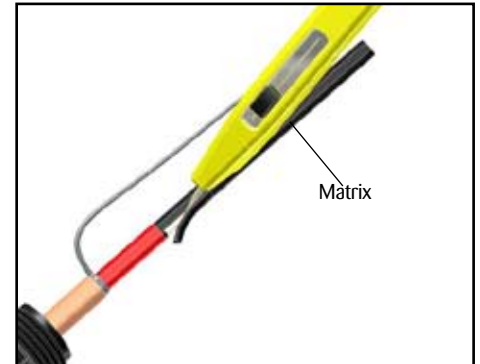

1.10. Skive outside of black matrix.



Do not cut bus wire strands.

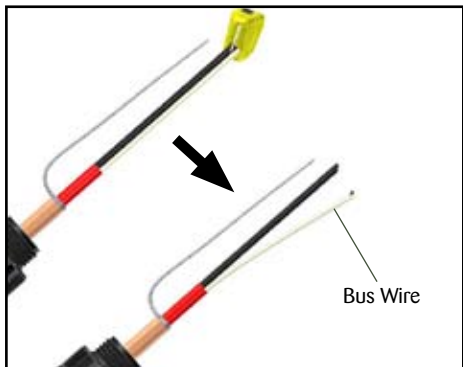

1.11. Cut V-Notch in matrix and pull bus wires from matrix. Cut and remove center matrix.



1.12. Apply a liberal amount of RTV sealant to cable.

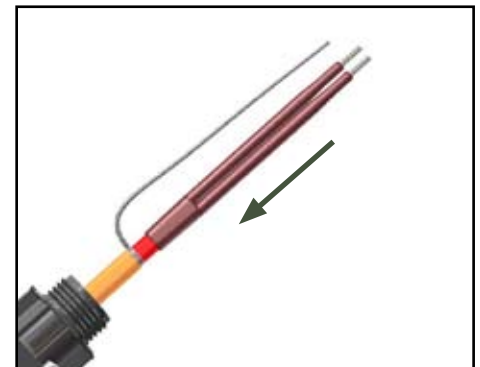

1.13. Slide boot onto the end of the cable.

End Termination for FLX-OJ Cables and HSX Cables

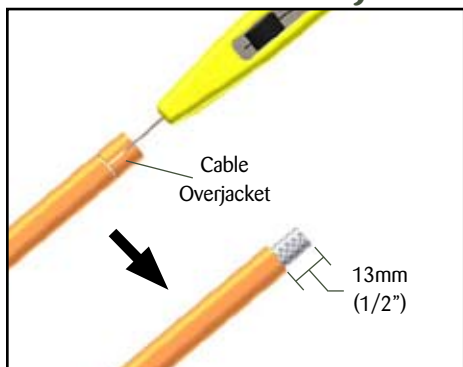

2.1. Cut and remove heating cable overjacket.

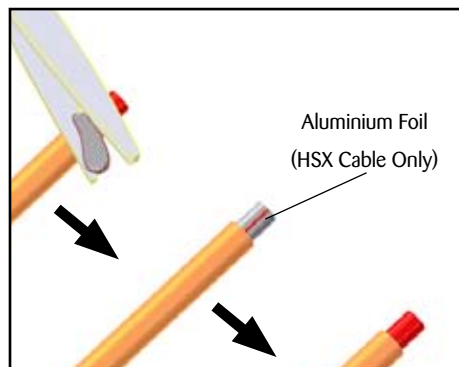

2.2. Trim ends of braid. Gently score the aluminium foil layer (HSX cable only) and peel away.

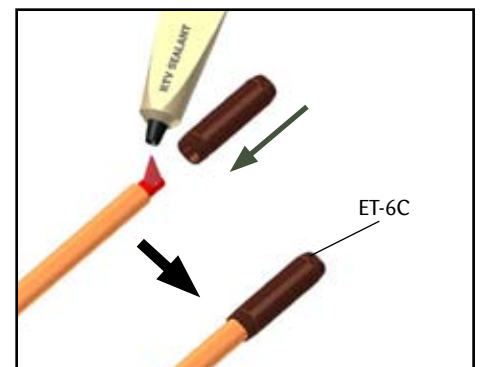

2.3. Apply a liberal amount of RTV sealant to cable and inside end cap. Slide end cap onto end of cable. For FLX-OJ or HSX proceed to Step 5.1 on page 6.

PCA-COM

Power connection for FLX-BC with braid only.

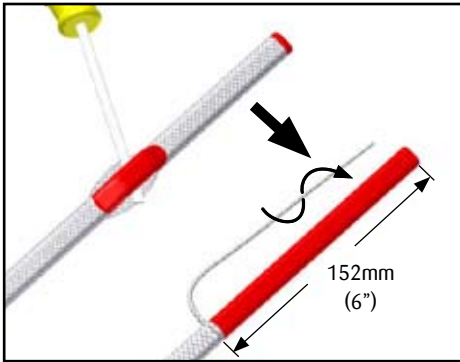

3.1. Separate braid strands at edge of overjacket and pull cable through opening.

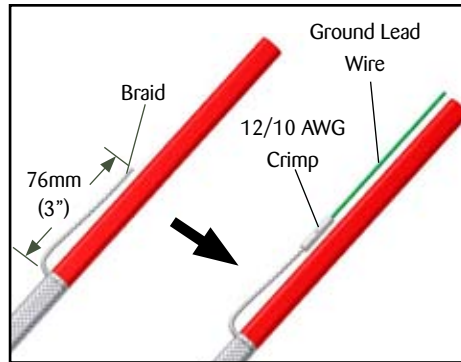

3.2. Trim braid to approximately 76mm (3"). Crimp 12/10 AWG compression lug to ground braid and ground lead.

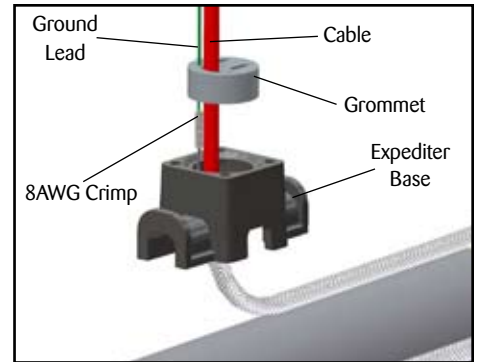

3.3. Feed cable and ground lead through expediter base as shown. Feed cable and ground lead through grommet (above the crimp).

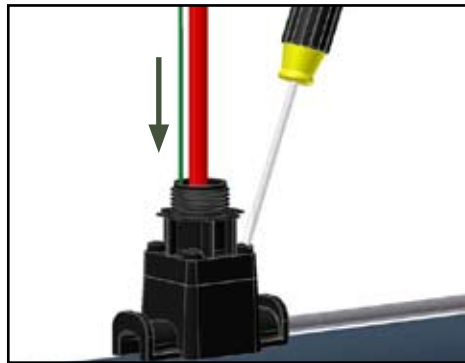

3.4. Slide expediter toward pipe and route cable through base, grommet, and NPT threaded cap. Secure cap to base with the captive screws.

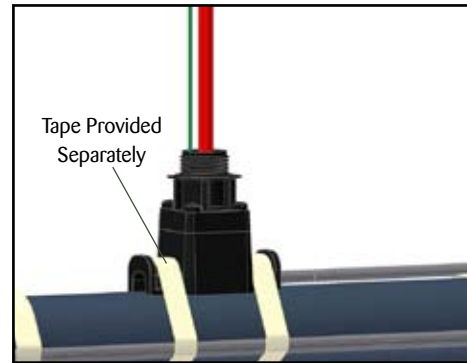

3.5. Mount expediter to pipe using two (2) circumferential bands of 19mm (3/4") wide tape.

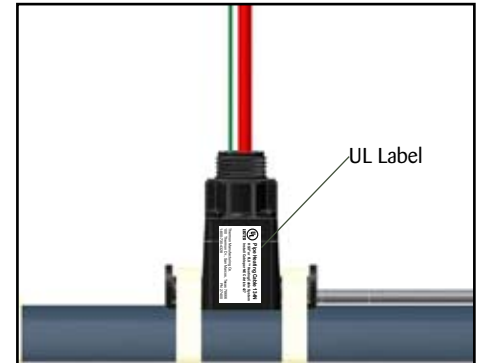

3.6. Place UL[®] label provided as shown, locate on opposite side from rectangular side opening.

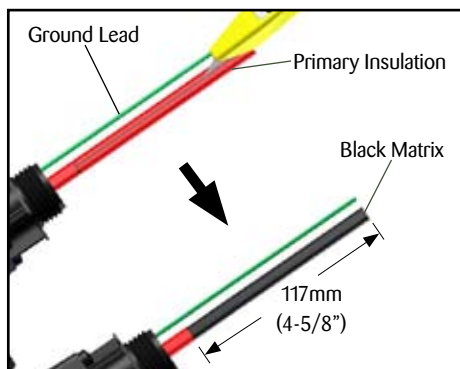

3.7. Cut and remove primary insulation jacket.

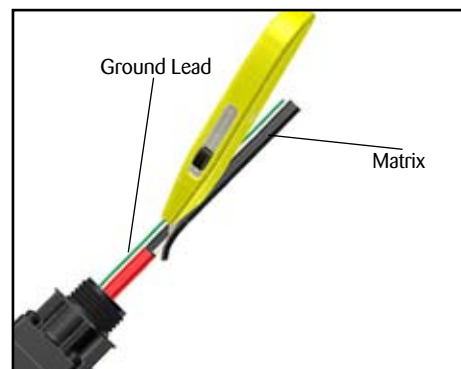

3.8. Skive outside of black matrix.

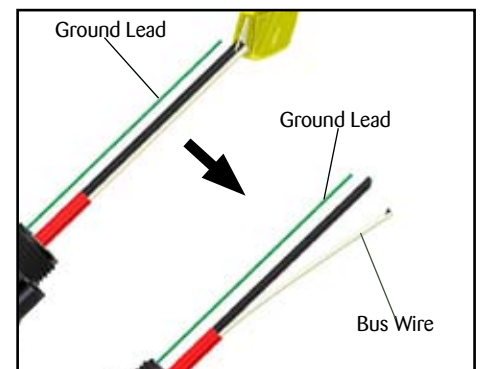

3.9. Cut V-Notch in matrix and pull bus wires from matrix. Cut and remove center matrix.



Do not cut bus wire strands.



The Heat Tracing Specialists[®]



3.10. Apply a liberal amount of RTV sealant to cable.



3.11. Slide boot onto the end of the cable.

End Termination for FLX-BC with braid only.

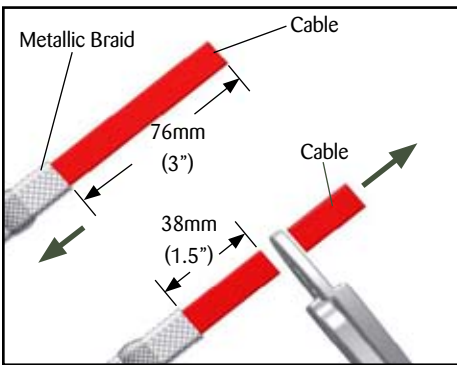

4.1. Slide the metallic braid back from the end of the cable and cut off 38mm (1.5") of cable.

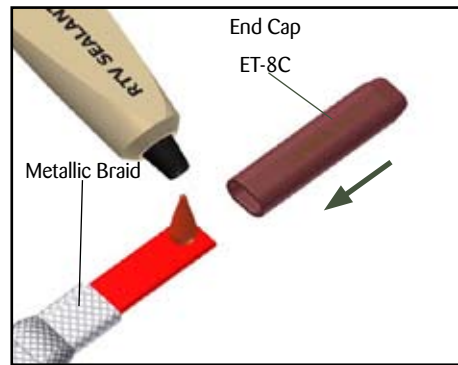

4.2. Apply RTV sealant liberally over the end of the cable and inside the end cap.

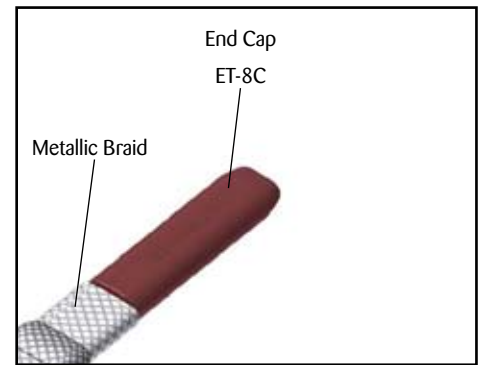

4.3. Slide the end cap onto the cable.

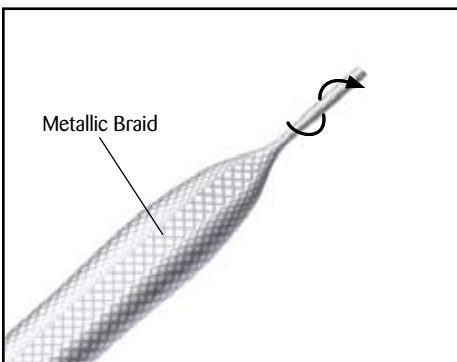

4.4. Slide the metallic braid over the end cap. Twist the ends of the metallic braid together.

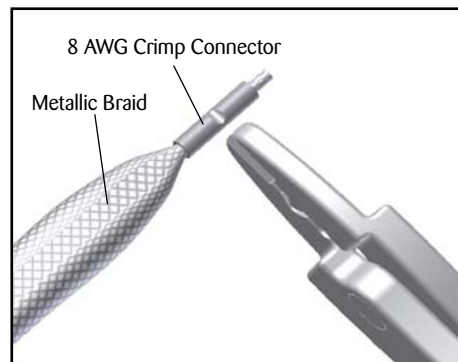

4.5. Slide 8 AWG crimp connector over end of braid, then crimp to secure braid.

INSTALLATION PROCEDURES

Mount Junction Box and Make Connections

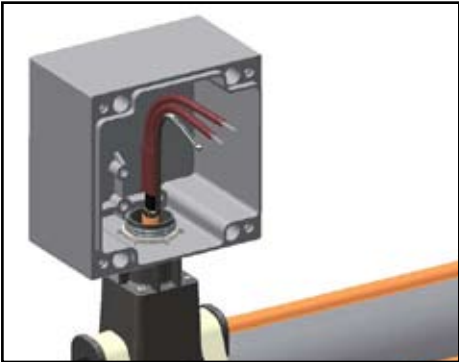

5.1. Mount junction box (Sold separately) on expediter using gasket and locknut provided.

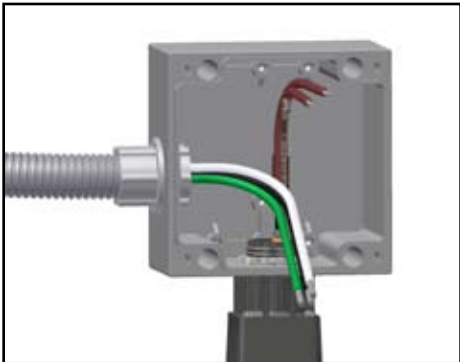

5.2. Install power connection fittings (supplied by others) and pull in power and ground wires.

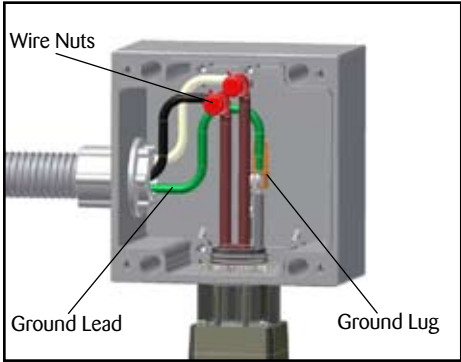

5.3. Complete system wiring. See typical wiring details below.

Typical Wiring Details

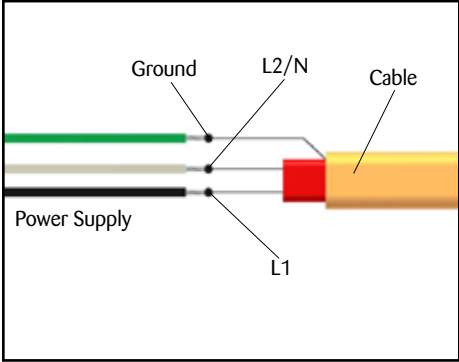

Power Connection-1 Cables.

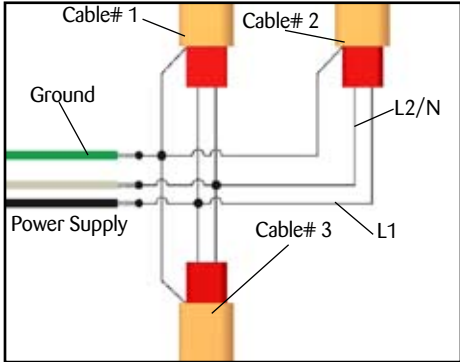

Power Connection-3 Cables.

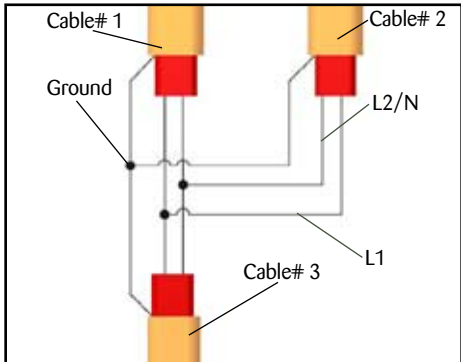

In-Line Splice and T-Splice

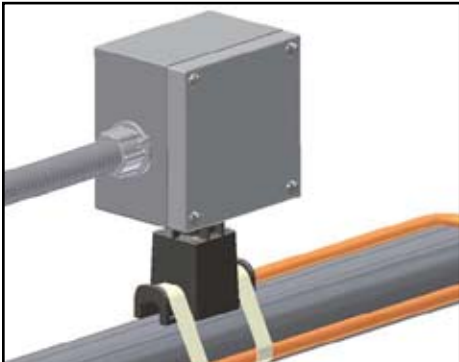

5.4. If using Thermon JB-K (sold separately) Install junction box lid using 4 captive screws.

INSTALLATION PROCEDURES

Cable Take-off for FLX and HSX

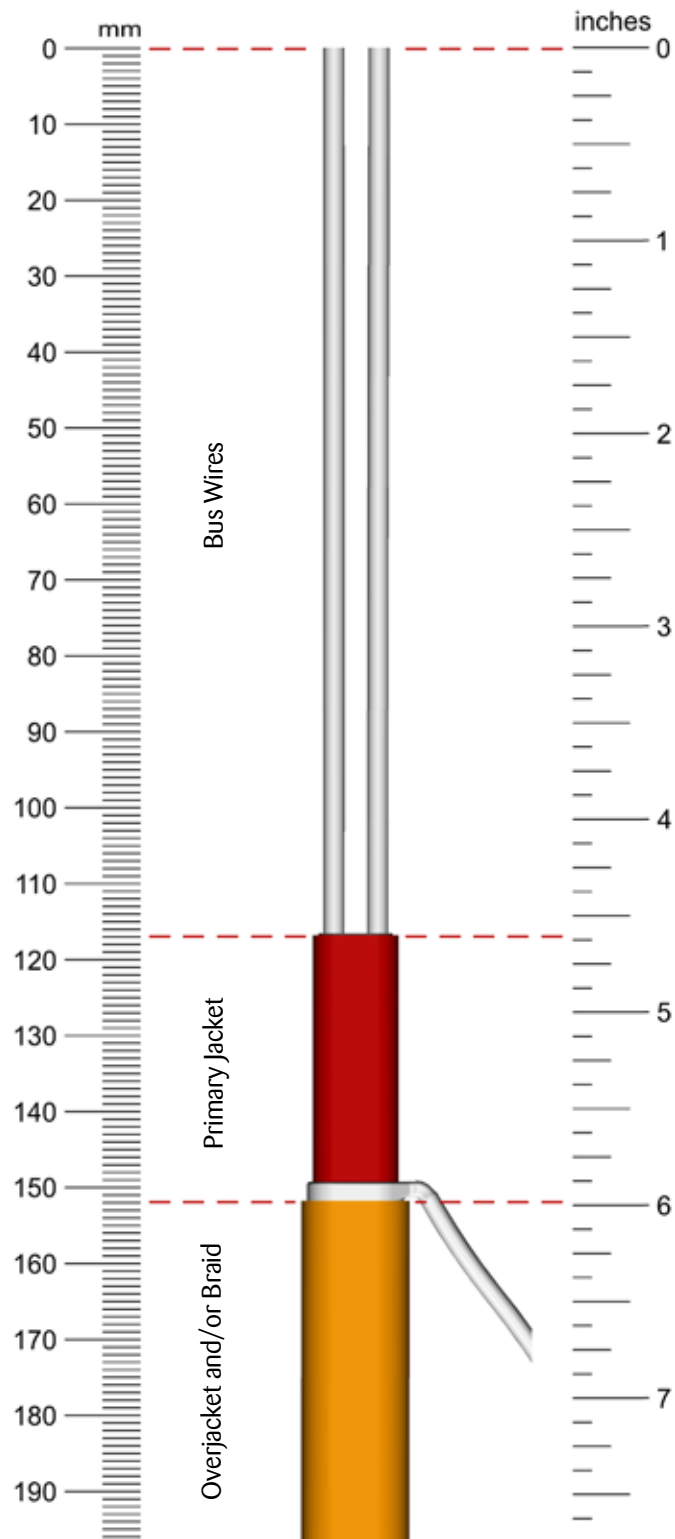

For Power Connection Boot Termination

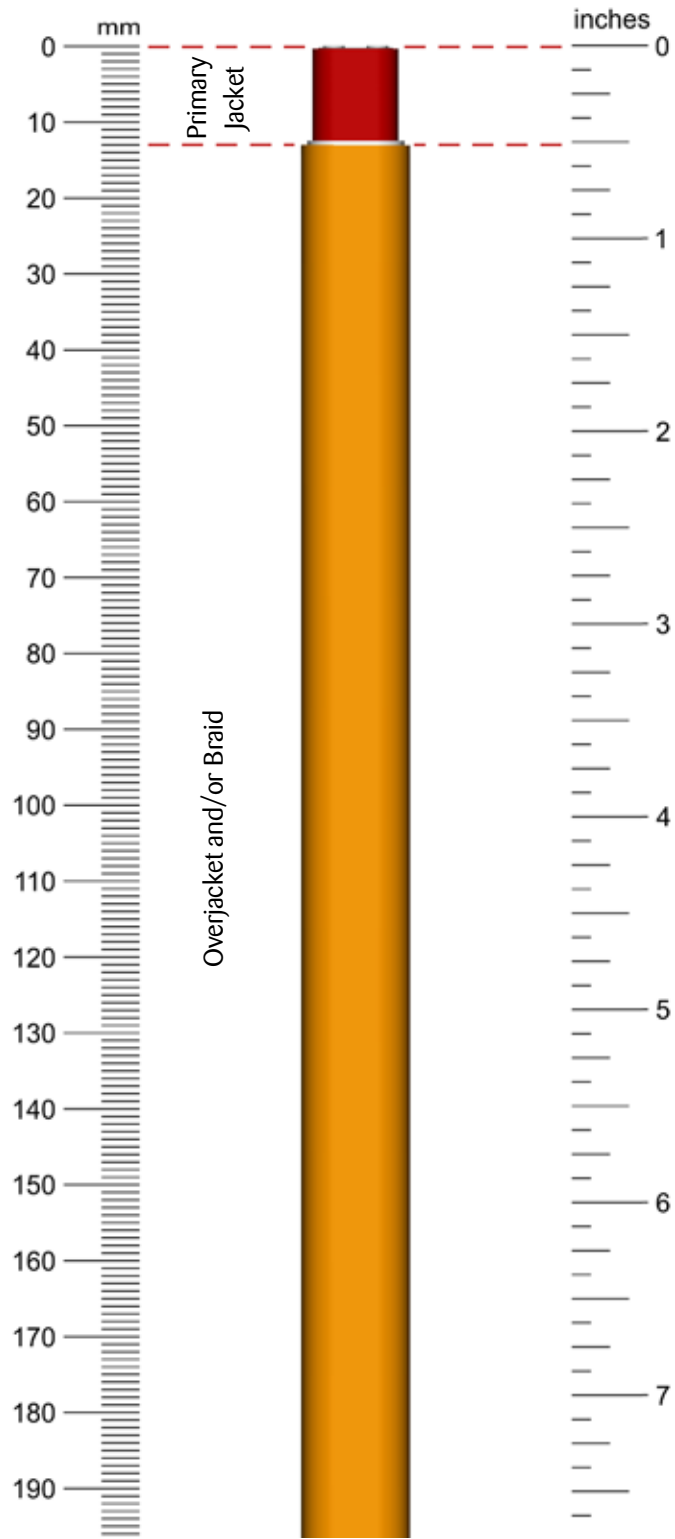

For End Cap Termination



ISO 9001
REGISTERED

THERMON . . . The Heat Tracing Specialists[®]

100 Theron Dr. • PO Box 609 • San Marcos, TX 78667-0609
Phone: 512-396-5801 • Facsimile: 512-396-3627 • **1-800-820-HEAT**
www.thermon.com In Canada call **1-800-563-8461**

Specifications and information subject to change without notice.

Form No. 50400-0208