

KSR-SK-DB

In-Line Splice Kit

KSR Snow Melting Cable

INSTALLATION PROCEDURES



The Heat Tracing Specialists[®]

KSR-SK-DB

The following installation procedures are suggested guidelines for the installation of in-line cable splices. They are not intended to preclude the use of other methods and good engineering or field construction practices.

Receiving, Storing and Handling . . .

1. Inspect materials for damage incurred during shipping.
2. Report damages to the carrier for settlement.
3. Identify parts against the packing list to ensure the proper type and quantity has been received.
4. Store in a dry location.

KSR-SK-DB In-Line Splice Kit

Kit Contents . . .

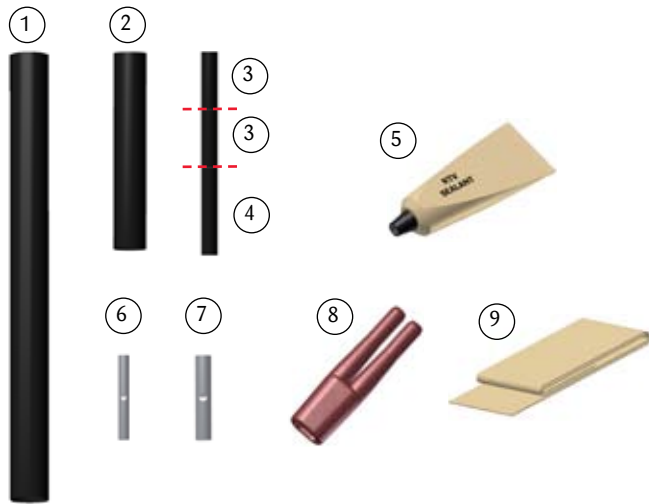

Item	Quantity	Description
1	1	Heat Shrink 28mm X 325mm (1.10" X 12.80")
2	1	Heat Shrink 20mm X 120mm (.79" X 4.72")
3 & 4	1	Heat Shrink 10mm X 125mm (.39" X 4.92") Cut heat shrink into 3 pieces per step 11
5	1	RTV Tube
6	2	Small Lug (14-16 AWG)
7	1	Large Lug (10-12AWG)
8	2	Power Connection Boot
9	1	Mastic Tape 25 mm X 150MM (.98" X 5.91")

Installation Precautions . . .

- To minimize the potential for arcing and fire caused by product damage or improper installation use ground-fault protection. The National Electrical Code (NEC) and Canadian Electrical Code (CEC) require ground-fault protection of equipment for each branch circuit supplying electric heat tracing.
- Installation must comply with Thermon requirements and be installed in accordance with the NEC, CEC, or any other applicable national and local codes.
- Power connections and end termination must be located in NEMA 4 or 4X enclosures (Thermon KSR-JB or UL Listed equivalent) located above moisture line.
- De-energize all power sources before opening enclosure.
- Keep ends of heating cable and kit components dry before and during installation.
- Do not locate the splice in an expansion joint area, where a bend occurs in the cable, or within a conduit entering or exiting a slab.
- Do not splice cables that have different catalog numbers and/or voltage ratings.
- Component approvals and performance rating are based on use of Thermon specified parts only.
- The kit instructions should be used in conjunction with the installation instruction for the heating cable and other accessory items.



Canadian Standard Association
Certified Snow Melting Equipment
for Applications Having a Type
Designation of 2B



Underwriters Laboratories Inc.
5N23 De-Icing and Snow Melting
Equipment (KOBQ)

Tools Required . . .



The Heat Tracing Specialists®

INSTALLATION PROCEDURES

In-Line Splice Instructions

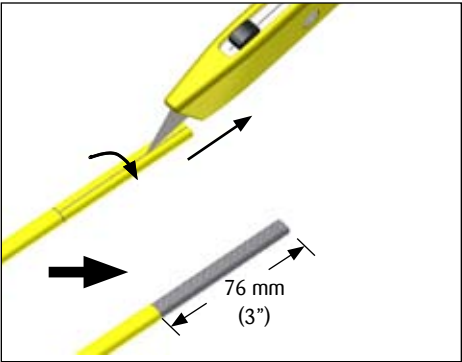

1. Cut and remove heating cable overjacket as shown.

 **Do not cut metallic braid.**



2. Separate braid strands at edge of overjacket and pull cable through opening in braid.

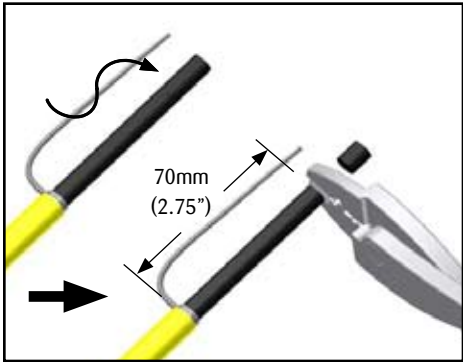

3. Twist braid into a pigtail. Cut end of cable 70mm (2.75") as shown.

 **Do not cut braid.**

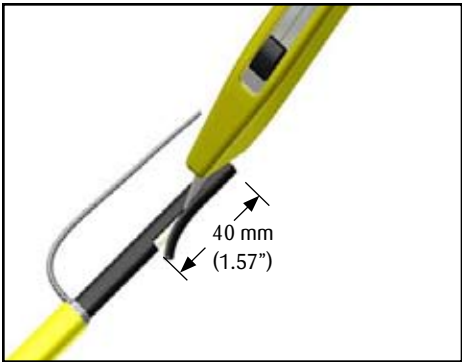

4. Skive outside edges of primary insulation and black matrix 40mm (1.57") as shown.

 **Do not cut bus wire strands.**

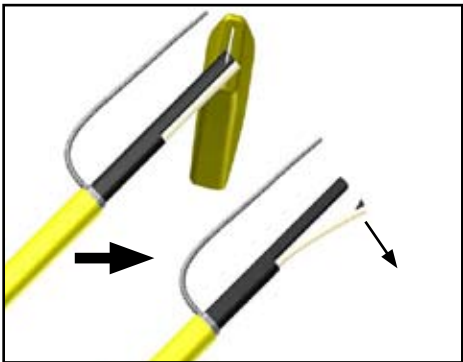

5. Cut V-notch in matrix and pull wires from matrix.

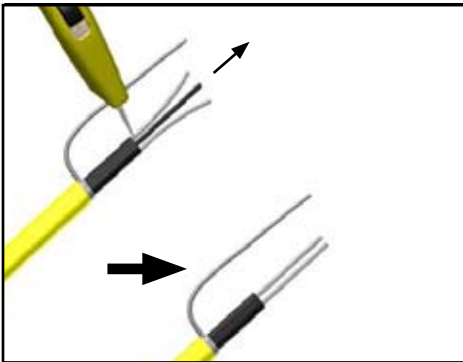

6. Cut and remove remaining center core of matrix.

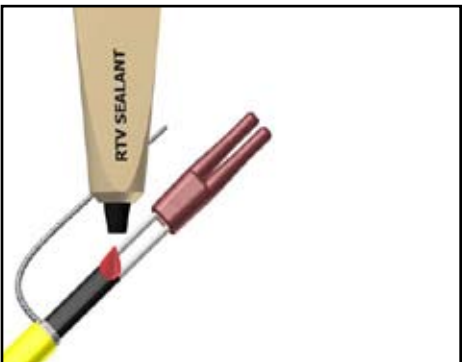

7. Apply a liberal amount of RTV sealant to cable.

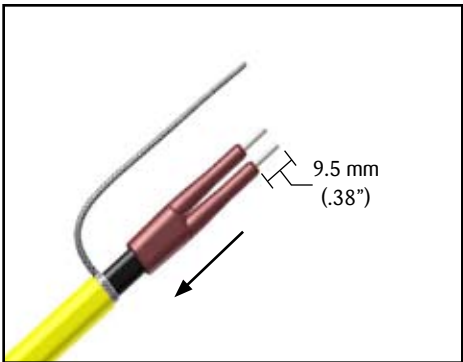

8. Slide boot onto the end of the cable.

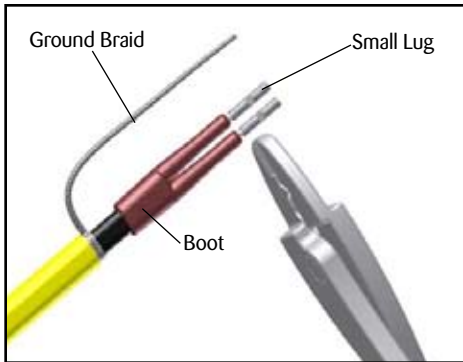

9. Crimp small lugs on end of bus wires.

KSR-SR-DB

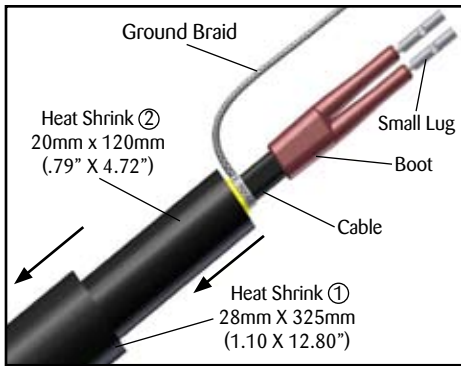

10. Slide heat shrink ① 28mm x 325mm (1.10" x 12.80") then heat shrink ② 20mm x 120mm (.79" x 4.72") onto cable as shown.

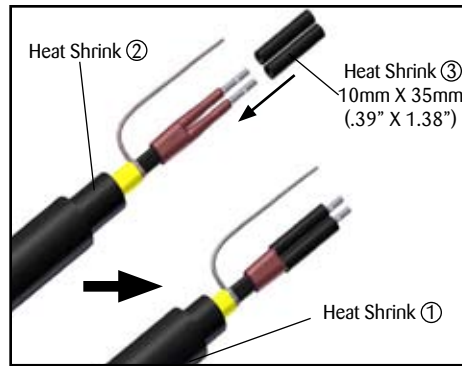

11. Cut 10mm X 125mm (.39" X 5") into 3 pieces : 3 ② pieces @ 35mm (1.38") ④ 1 piece @ 55mm (2.16"). Slide heat shrink ③ 10mm X 35mm (.39" X 1.38") over small lugs on each splice connection boot legs.

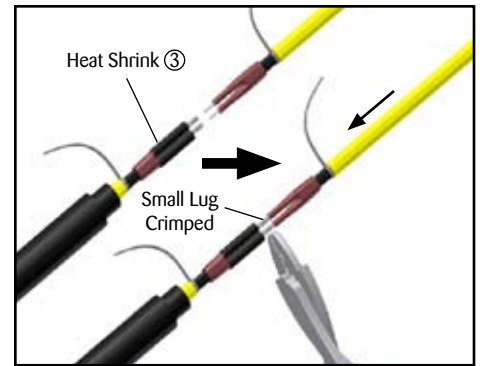

12. Repeat steps 1-8 for second cable to be spliced. Crimp the small lugs to the second cable.

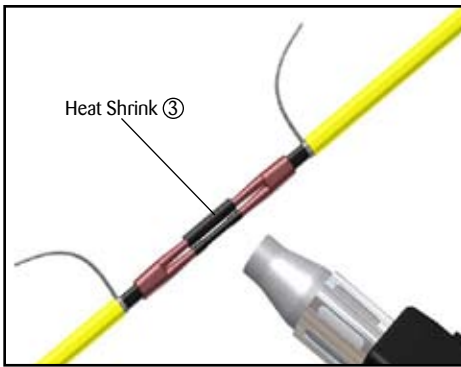

13. Center heat shrink ③ over crimped small lugs. Using heat gun, heat until heat shrinks firmly set.

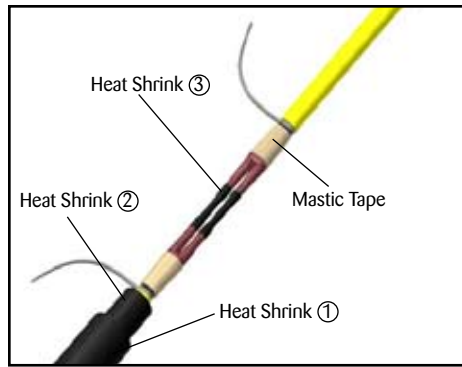

14. Cut 2 pieces of mastic tape about 25mm (1") long. Stretch mastic tape to cover the end of each splice connection boot and cable primary insulation jacket up to metallic braid.

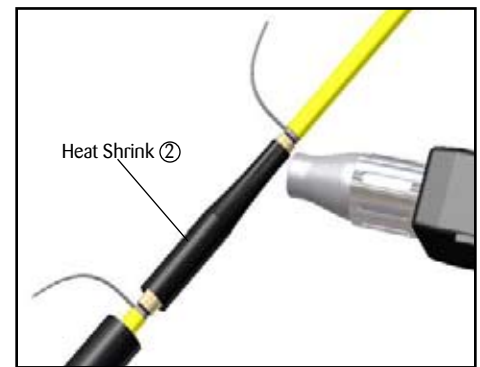

15. Center shrink ② over splice connection area. Using heat gun, heat until heat shrink firmly sets.

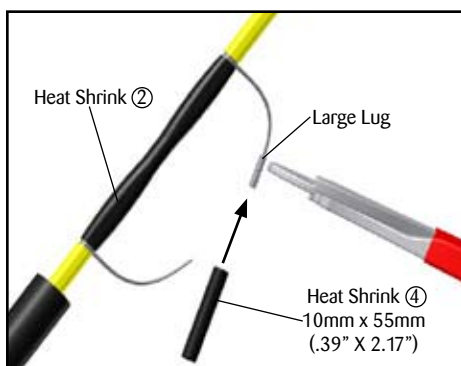

16. Crimp large lug on one of the braid as shown. Slide heat shrink ④ over the braid with large lug.

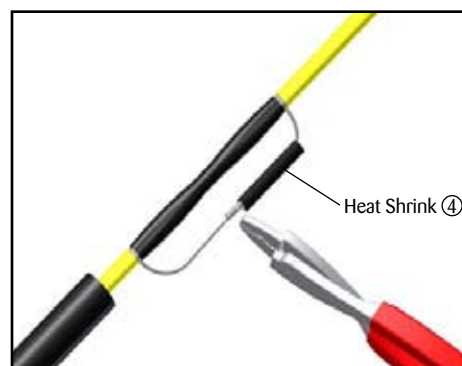

17. Crimp large lug to the end of the other braid.

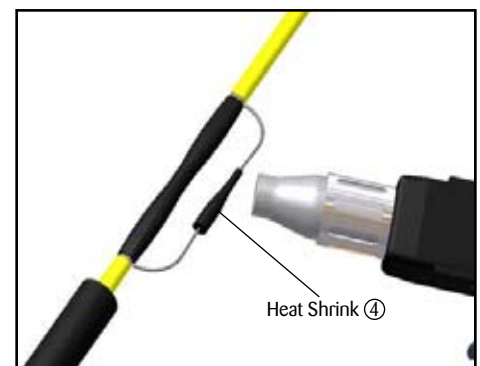

18. Center heat shrink ④ over crimped lug. Using heat gun, heat until heat shrink firmly sets.



The Heat Tracing Specialists®

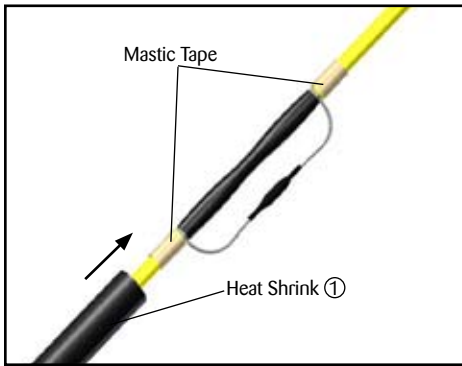

19. Cut two pieces of mastic tape about 25mm (1") long. Stretch mastic tape to cover the yellow cable jacket on each cable.

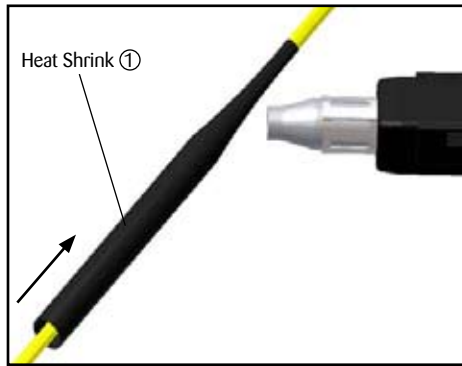

20. Center heat shrink ① over the splice connection area. Using heat gun, heat until heat shrink firmly sets.



21. Completed splice.

INSTALLATION PROCEDURES

Cable Take-Off

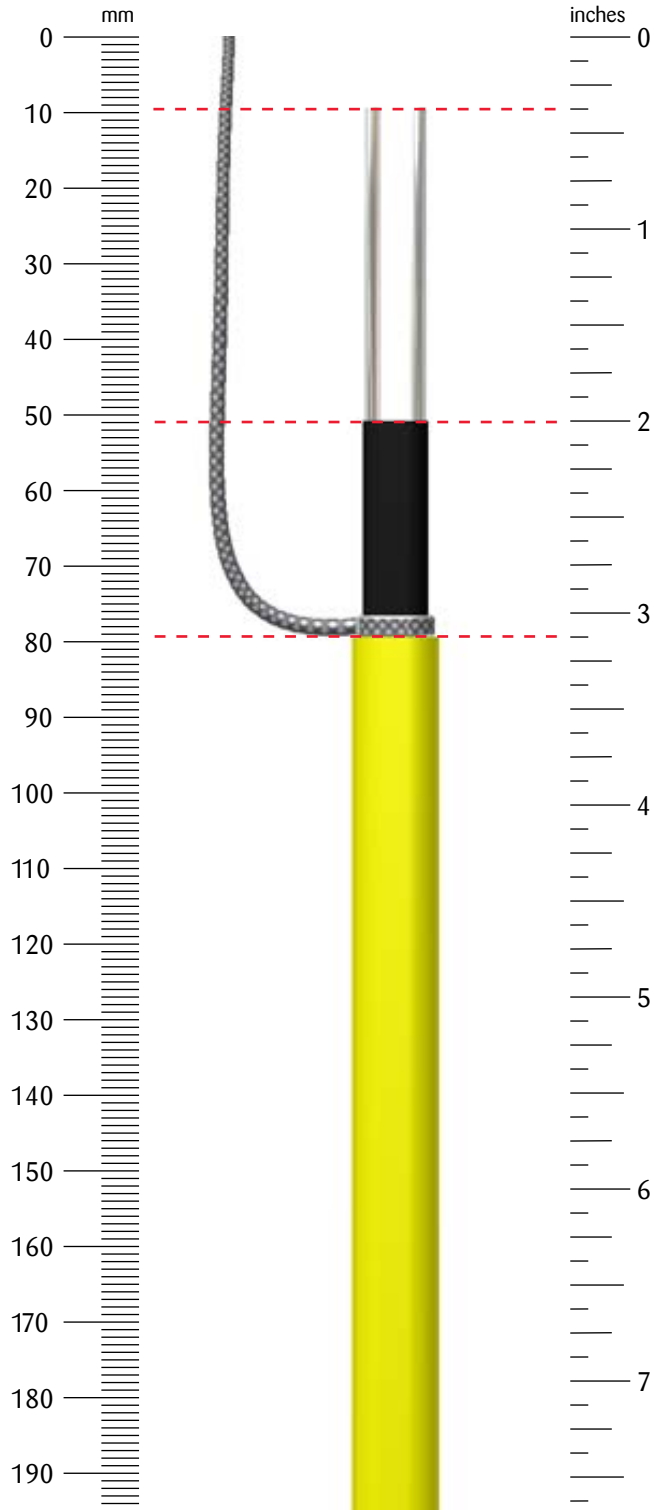

For In-Line Splice



ISO 9001
REGISTERED

THERMON . . . The Heat Tracing Specialists®

100 Thermon Dr. • PO Box 609 • San Marcos, TX 78667-0609
Phone: 512-396-5801 • Facsimile: 512-396-3627 • **1-800-820-HEAT**
www.thermon.com In Canada call **1-800-563-8461**

Specifications and information are subject to change without notice.

Form 50252-0707